

TSW212

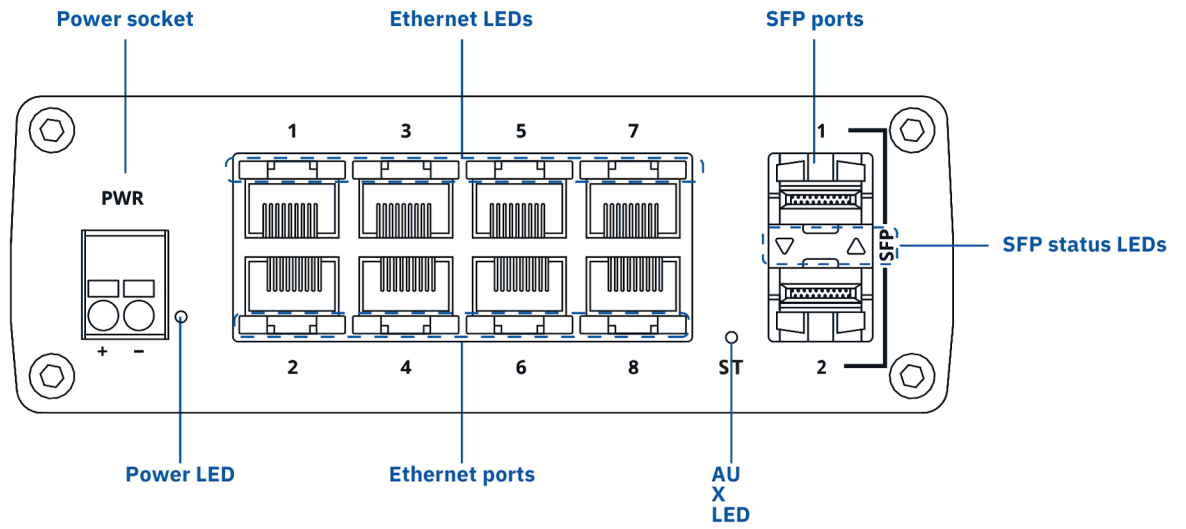

HARDWARE

FRONT VIEW



BACK VIEW

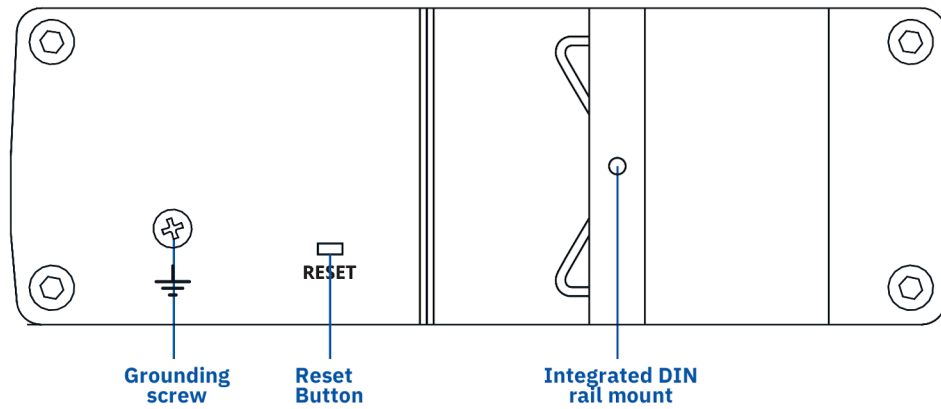

RJ45 LED MEANING

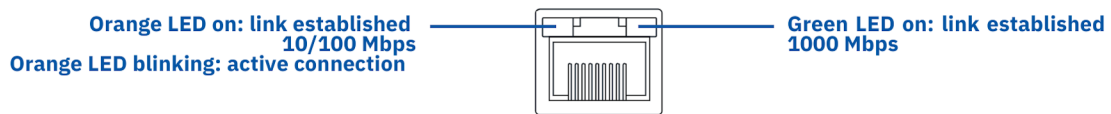

POWER SOCKET PINOUT

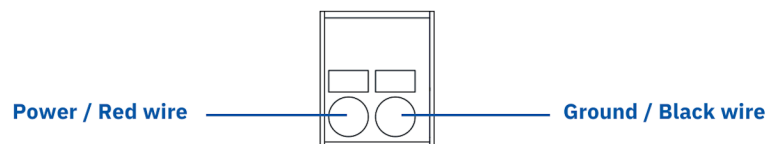

SFP LED MEANING

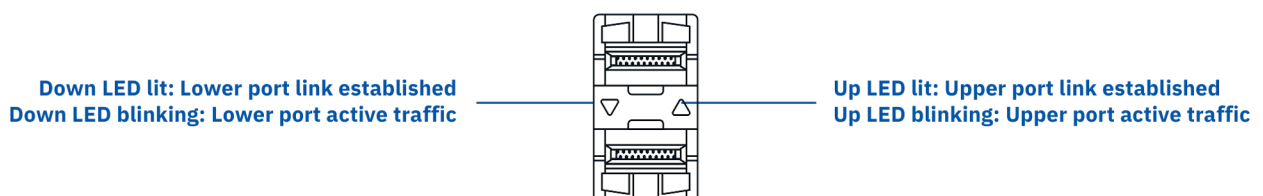

FEATURES

ETHERNET

ETH	Multi-layer managed 8 x ETH ports, 10/100/1000 Mbps supports auto MDI/MDIX crossover
Fibre	2 x SFP ports
IEEE 802.3 series standards	802.3i, 802.3u, 802.3ab, 802.3x

SERVICES

EtherNet/IP	Ye
Profinet (class B)	s
SNMP V2, V3	Ye
LLDP	s

NETWORK

MRP	MRP client role, MRP manager role
L2 features	Loop protection, Forwarding table, VLAN, STP/RSTP
DHCP	DHCP server, DHCP client
Port Settings	Enable/disable, link speed control, port isolation, EEE (802.3az) management, Port Mirroring
L3 Features	Static IPv4 routing, static IPv6 routing, DHCPv6 client, static IPv6 address

QOS

QOS	Port priority, DSCP priority, 802.1p priority, TOS
Scheduling method	SP/WFQ/WRR
Bandwidth control	Rate limiting, storm control
Traffic Shaper	Port-based shaping

DIAGNOSTICS

Tools	Cable diagnostic, ping, traceroute, nslookup
-------	--

SYSTEM CHARACTERISTICS

RAM	128MB, DDR3
FLASH storage	16 MB serial flash

FIRMWARE / CONFIGURATION

WEB UI	Update FW from file, check FW on server, configuration profiles, configuration backup
FOTA	Update FW
RMS	Update FW/configuration for multiple devices at once
Keep settings	Update FW without losing current configuration

FIRMWARE CUSTOMISATION

Operating system	TSWOS (OpenWrt based Linux OS)
Supported languages	Busybox shell, Lua, C, C++
Development tools	SDK package with build environment provided

PERFORMANCE SPECIFICATIONS

Bandwidth (Non-blocking)	20 Gbps
Forwarding rate	14.88 Mpps
Packet buffer	512 KB
MAC address table size	8K entries
Jumbo frame support	10000 bytes

POWER

Connector	2-pin industrial DC power socket
Input voltage range	7 - 57 VDC
Power consumption	Idle: < 2.5 W / Max: 6 W

PHYSICAL INTERFACES

Ethernet	8 x RJ45 ports, 10/100/1000 Mbps
Fibre	2 x SFP ports
Status LEDs	1 x Power LED, 1 x Aux LED, 16 x ETH status LEDs, 2 x SFP status LEDs
Power	1 x 2-pin industrial DC power socket
Reset	Software reset button
Grounding	1 x Grounding screw

PHYSICAL SPECIFICATION

Casing material	Anodized aluminum housing and panels
Dimensions (W x H x D)	132 x 44.2 x 122.2 mm
Weight	615 g
Mounting options	Integrated DIN rail bracket, wall mounting (additional kit needed), flat surface placement

OPERATING ENVIRONMENT

Operating temperature	-40 °C to 75 °C
Operating humidity	10 % to 90 % non-condensing IP30
Ingress Protection Rating	

REGULATORY & TYPE APPROVALS

Regulatory	CE, UKCA, RCM, ANRT, FCC, IC, CB, RoHS, REACH
------------	---

EMC EMISSIONS & IMMUNITY

Standards	EN 55032:2015 + A11:2020 + A1:2020 EN 55035:2017 + A11:2020 EN IEC 61000-3-2: 2019 + A1:2021 EN 61000-3-3: 2013 + A1:2019 + A2:2021
ESD	EN 61000-4-2:2009
Radiated Immunity	EN IEC 61000-4-3:2020
EFT	EN 61000-4-4:2012
Surge Immunity (AC Mains Power Port)	EN 61000-4-5:2014 + A1:2017
CS	EN 61000-4-6:2014
DIP	EN 61000-4-11:2020

SAFETY

Standards	CE: EN IEC 62368-1:2020 + A11:2020 RCM: AS/NZS 62368.1:2022 CB: IEC 62368-1:2018
-----------	---

STANDARD PACKAGE*

- TSW212
- QSG (Quick Start Guide)
- Packaging box



* Standard package contents may differ based on standard order codes.

CLASSIFICATION CODES

HS Code: 851762
 HTS: 8517.62.00

For more information on all available packaging options – please contact us directly.

AVAILABLE VERSIONS

HARDWARE VERSION	SUPPORTED FREQUENCIES	STANDARD ORDER CODE / PACKAGE CONTAINS
TSW212 *****	N/A	TSW212000000 / Standard package

TSW212 SPATIAL MEASUREMENTS

MAIN MEASUREMENTS

W x H x D dimensions for TSW212:

Device housing*: 132 x 44.2 x 122.2 mm

Box: 125 x 136 x 47 mm

*Housing measurements are presented without screws; for measurements of other device elements look to the sections below.

TOP VIEW

The figure below depicts the measurements of TSW212 and its components as seen from the top:

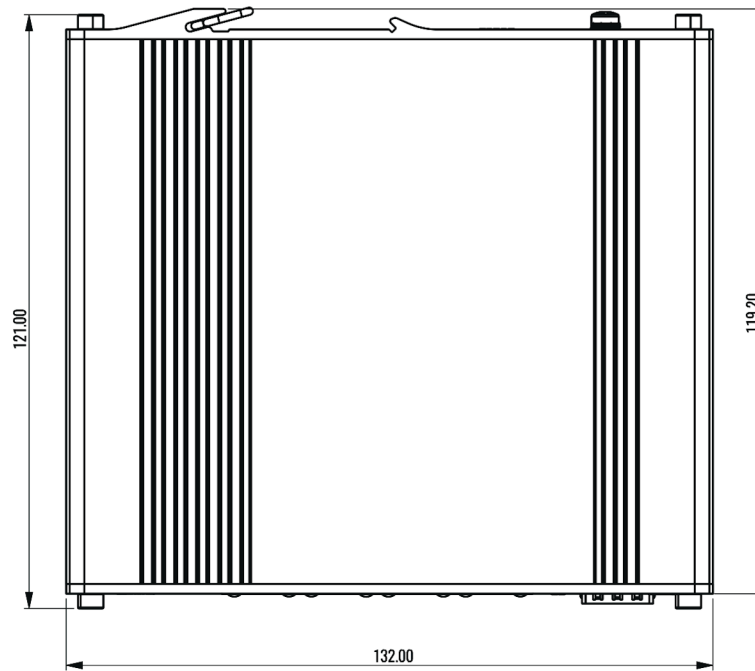

RIGHT VIEW

The figure below depicts the measurements of TSW212 and its components as seen from the right side:

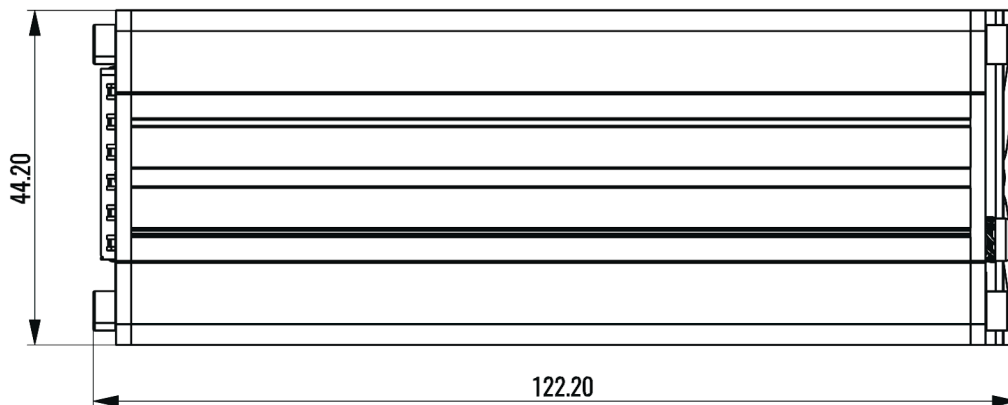

FRONT VIEW

The figure below depicts the measurements of TSW212 and its components as seen from the front panel side:

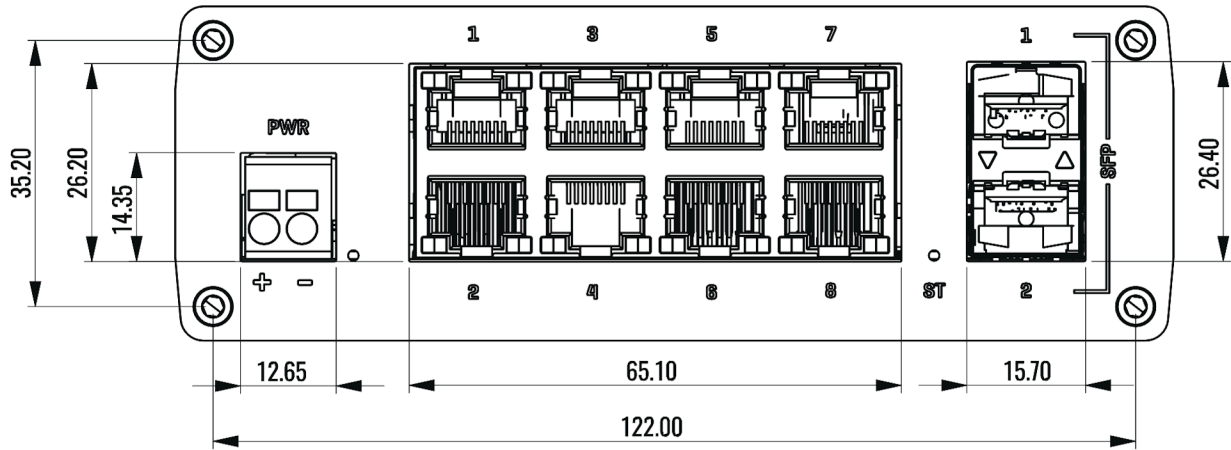

REAR VIEW

The figure below depicts the measurements of TSW212 and its components as seen from the back panel side:

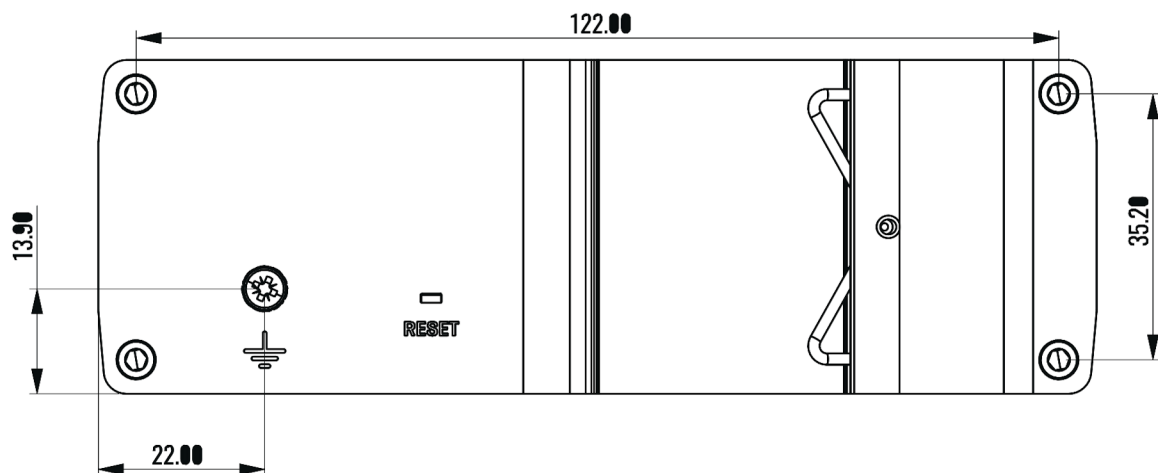

MOUNTING SPACE REQUIREMENTS

The figure below depicts an approximation of the device's dimensions when cables are attached:

